

New DISTO™ products

The new Leica DISTO™ Plan App Introduction

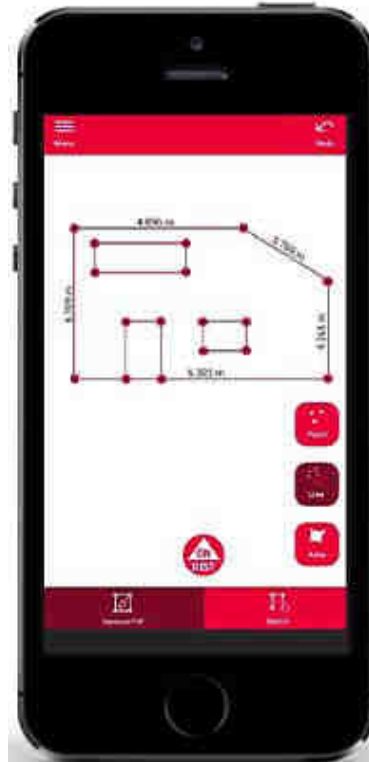

What is DISTO Plan?

- ✓ App to complement DISTO hardware
- ✓ Supports advanced measurement functions
- ✓ Allows data management
- ✓ Exports in JPG, PDF and CAD formats

The new Leica DISTO™ Plan App Compatibility

- ✓ Supports all DISTO™ devices with Bluetooth® Smart functionality and DISTO™ S910 via WiFi™
- ✓ Compatible with Android 6, 7 and 8
- ✓ Compatible with iOS 10 and 11



- when it has to be right

Leica
Geosystems

The new Leica DISTO™ Plan App

Functions overview

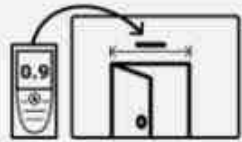

Sketch on Photo



Measure Plan

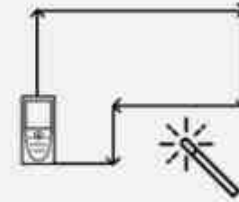

Smart Room



Sketch Plan



Measure Facade



Organiser

- when it has to be right

Sketch on Photo

Function overview

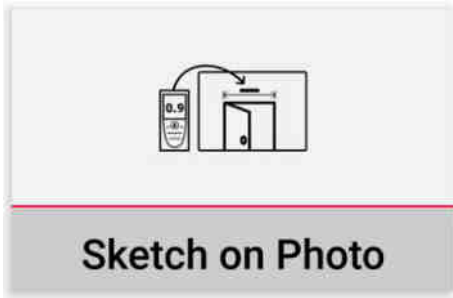

- ✓ Sketch lines and areas onto a picture
- ✓ Measure with DISTO and add measurement to the sketch
- ✓ Export in JPG or PDF format for easy sharing
- ✓ Compatible with every DISTO supporting Bluetooth connectivity



- when it has to be right

Leica
Geosystems

Sketch Plan

Function overview

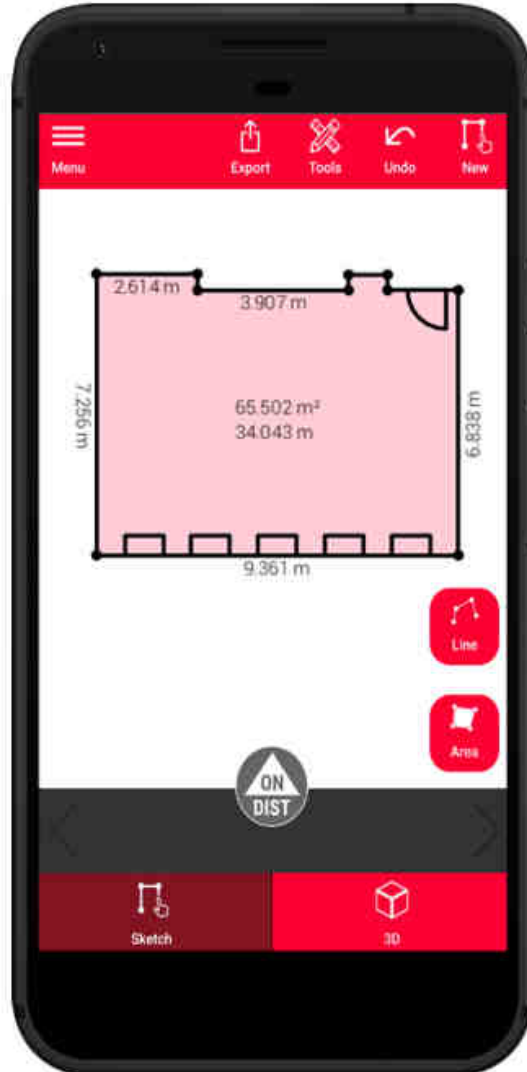

- ✓ Draw lines and areas by tapping or swiping
- ✓ Add DISTO measurements and the sketch is automatically auto-scaled
- ✓ Add wall openings, doors and windows
- ✓ Navigate your sketch in 3D
- ✓ Export in JPG or PDF format for easy sharing
- ✓ Compatible with every DISTO supporting Bluetooth connectivity

Sketch Plan Workflow

1. Sketch a floorplan or any situation map

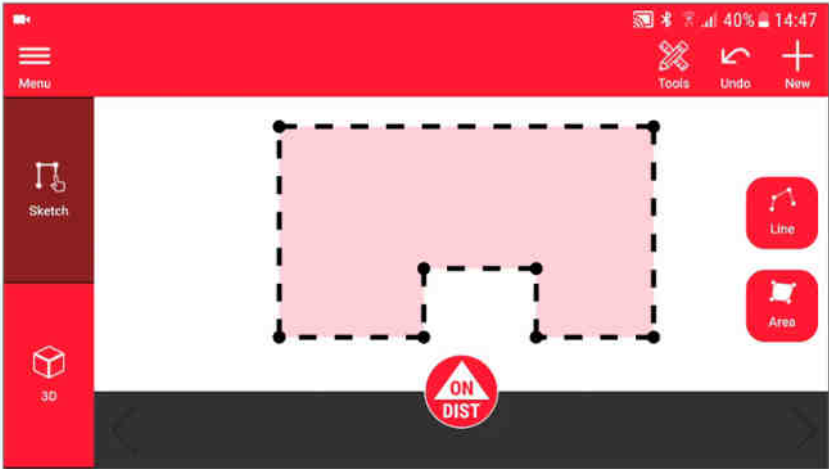

2. Add DISTO measurements

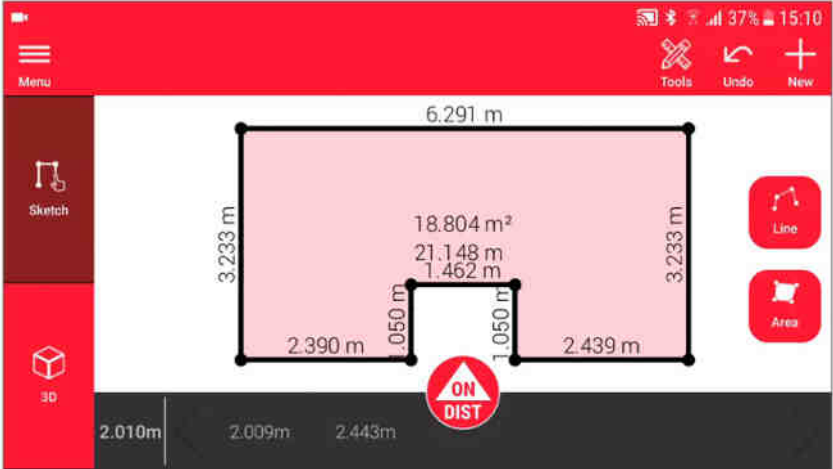

3. Add doors and windows



4. View sketch in 3D

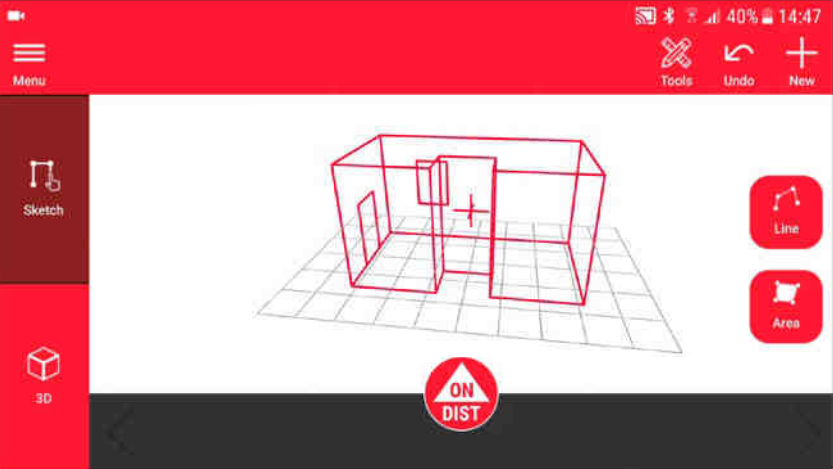

- when it has to be right



Smart Room

Function overview

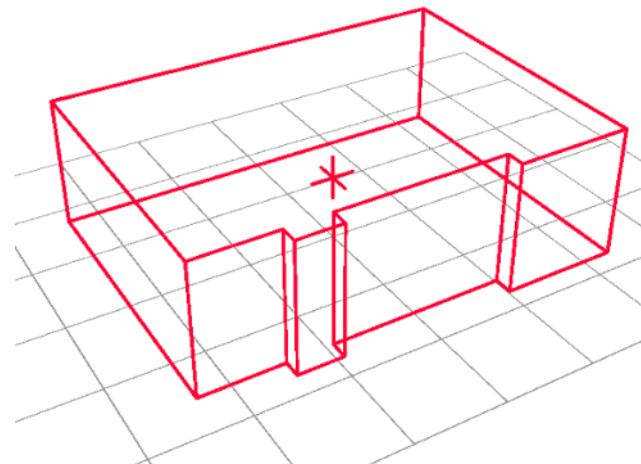
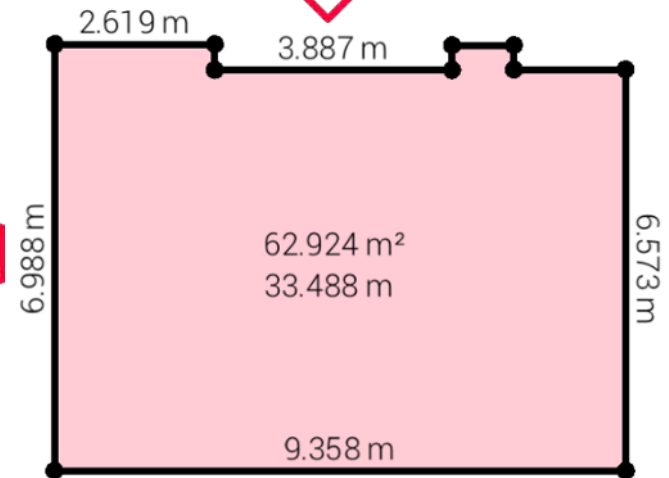
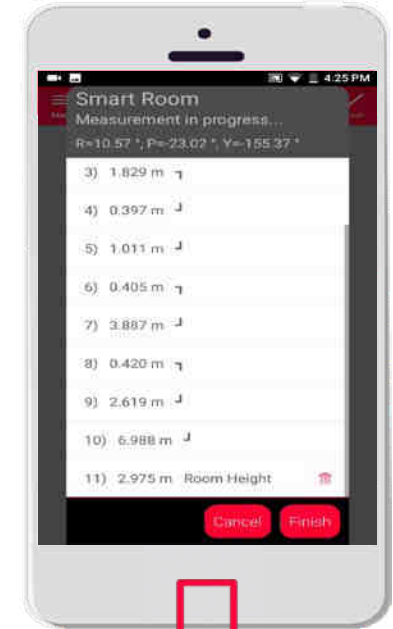
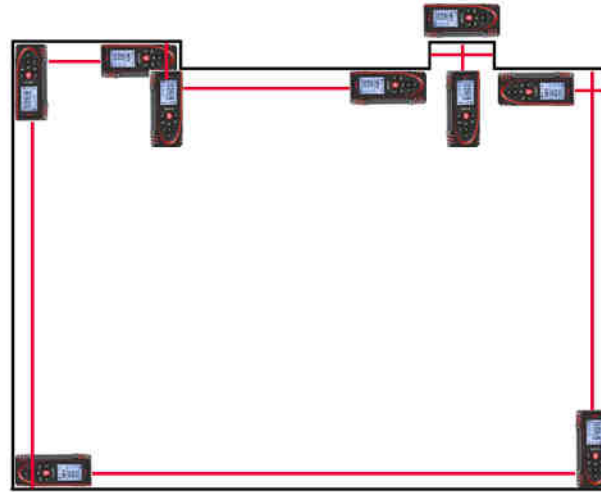
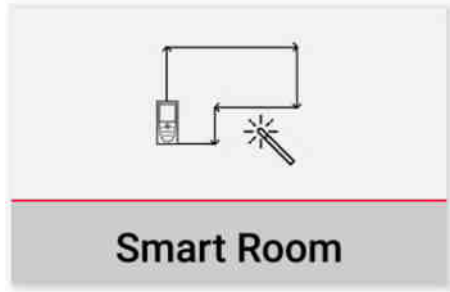

- ✓ Supported by the new DISTO X3/X4
- ✓ Automatically creates scaled floorplans by measuring distances
- ✓ Assigns room height to the floorplan to transform it into a 3D model
- ✓ Export in JPG, PDF and 2D and 3D DWG/DXF format

- when it has to be **right**



Smart Room Workflow

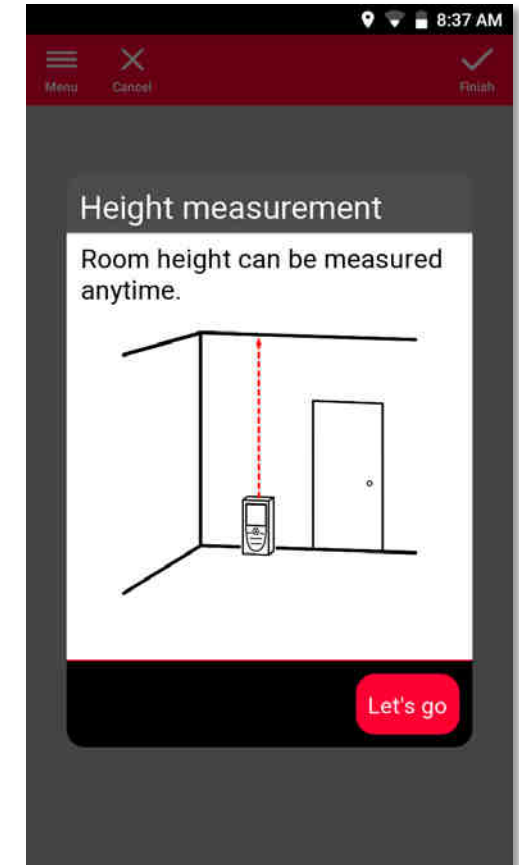
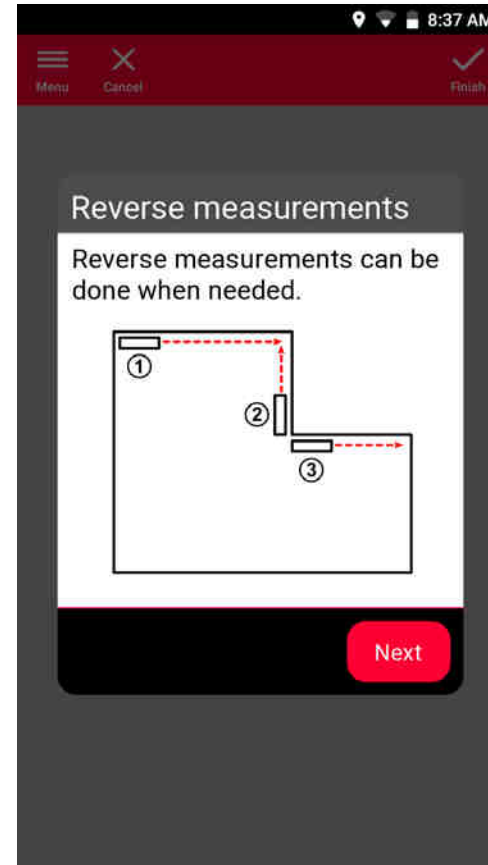
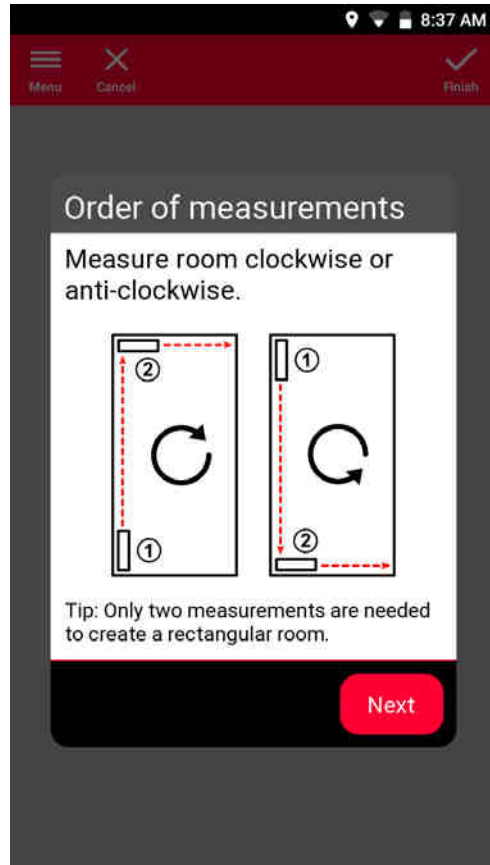
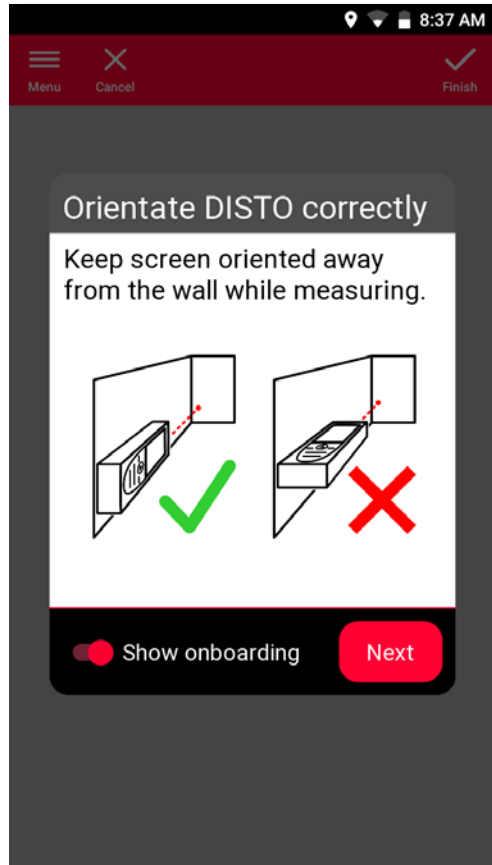

Measure Plan

Function overview



Point-to-Point technology for measuring irregular and big shapes



Calculate hidden corners with the intersect function



Export in JPG, PDF and 2D/3D/Raw CAD format



Compatible with DISTO S910 and DISTO X3/X4 on DST 360

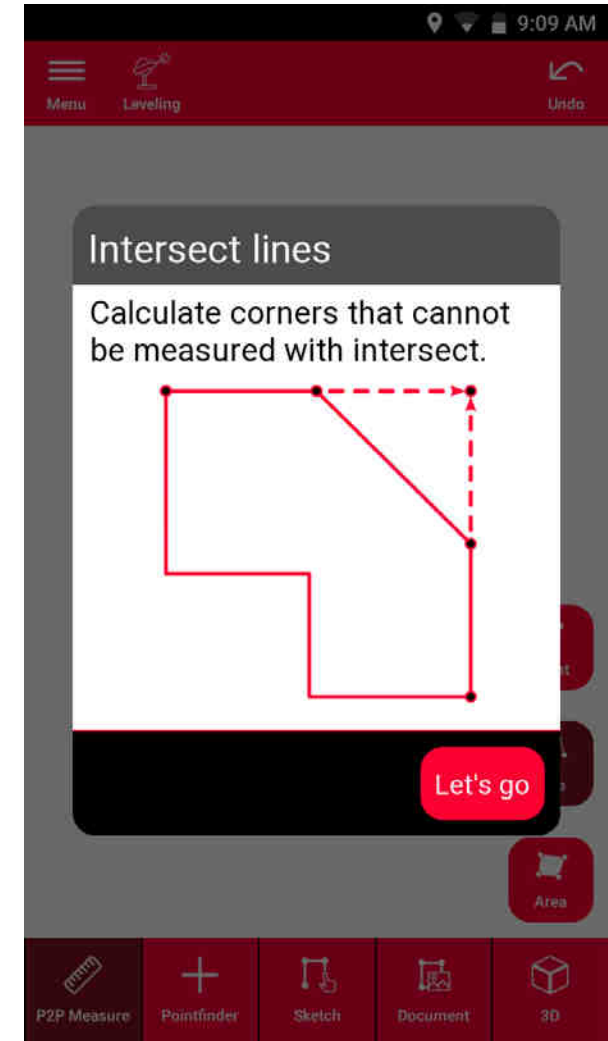
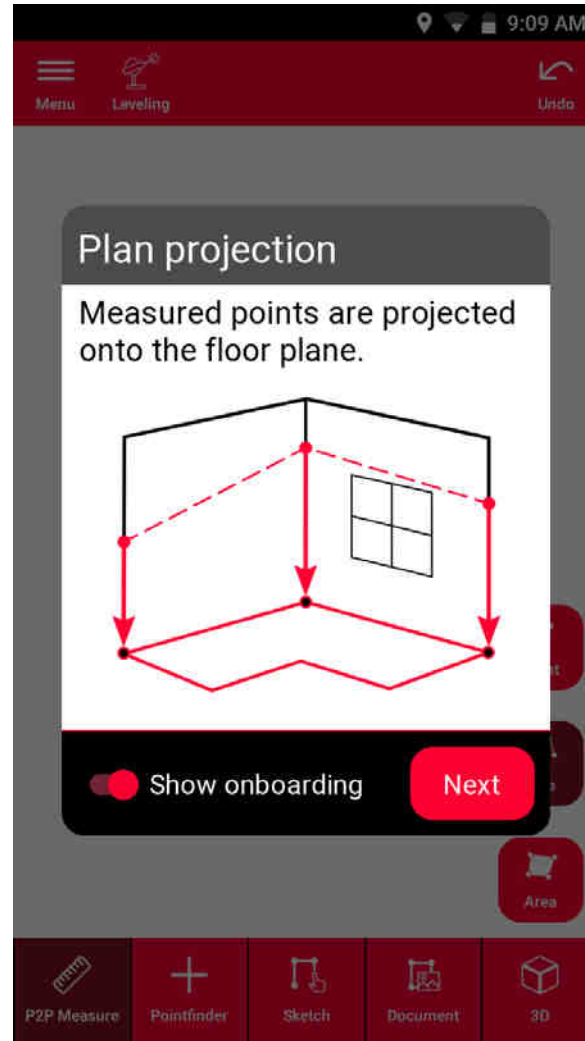

- when it has to be right



Measure Plan

Measure hidden corners

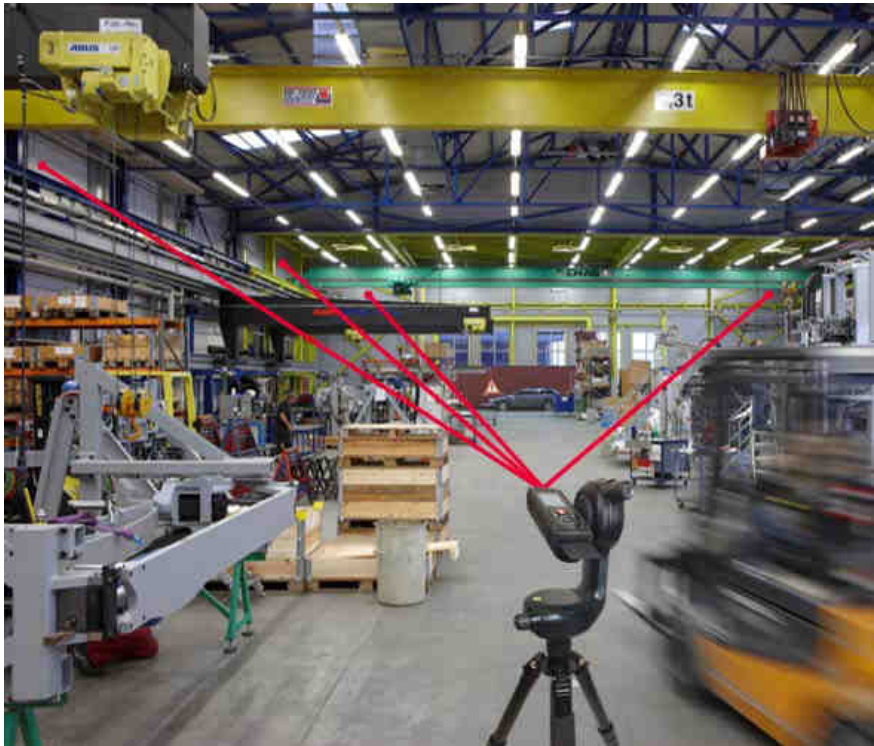

Measure two visible points on each wall



Select the edge

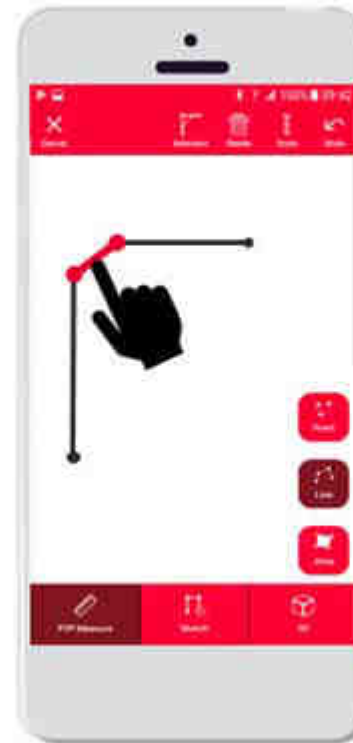

Use Intersect to calculate the corner



- when it has to be right

Leica
Geosystems

Measure Facade

Function overview



- ✓ Point-to-Point technology for measuring 2D plans of vertical surfaces
- ✓ Measure doors and windows
- ✓ Export in JPG, PDF and 2D DWG/DXF format
- ✓ Compatible with DISTO S910 and DISTO X3/X4 on DST 360

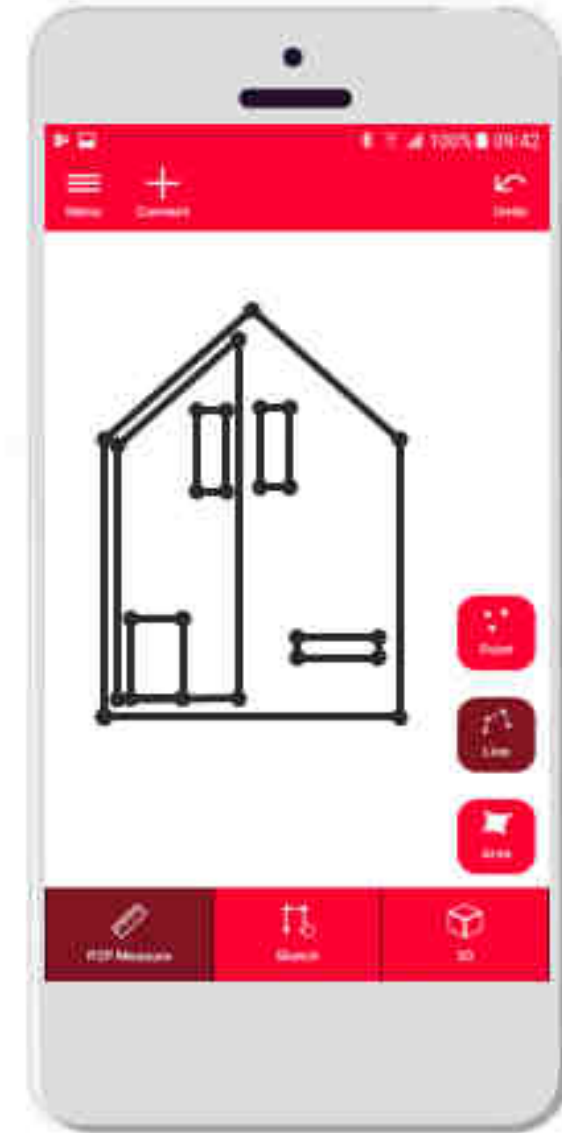

- when it has to be right

Measure Facade Workflow

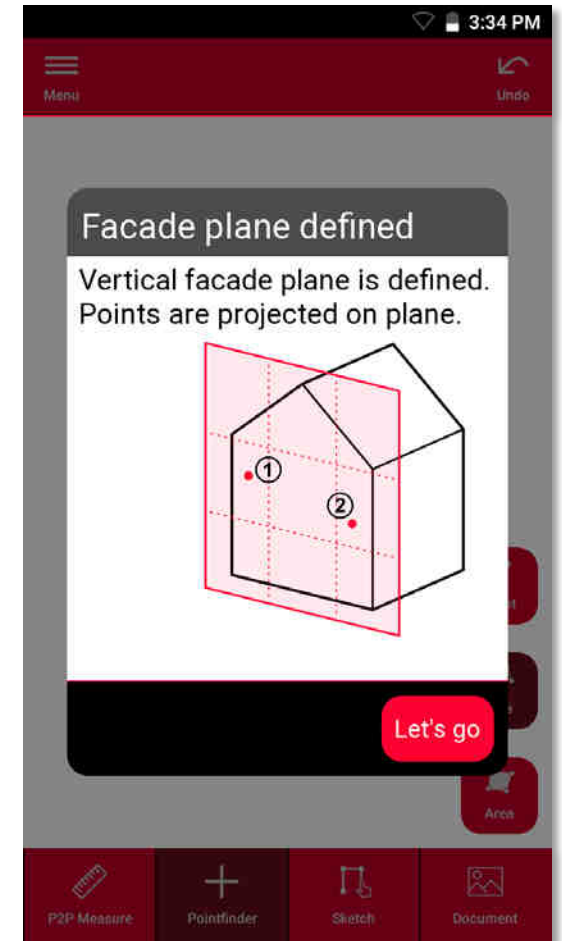
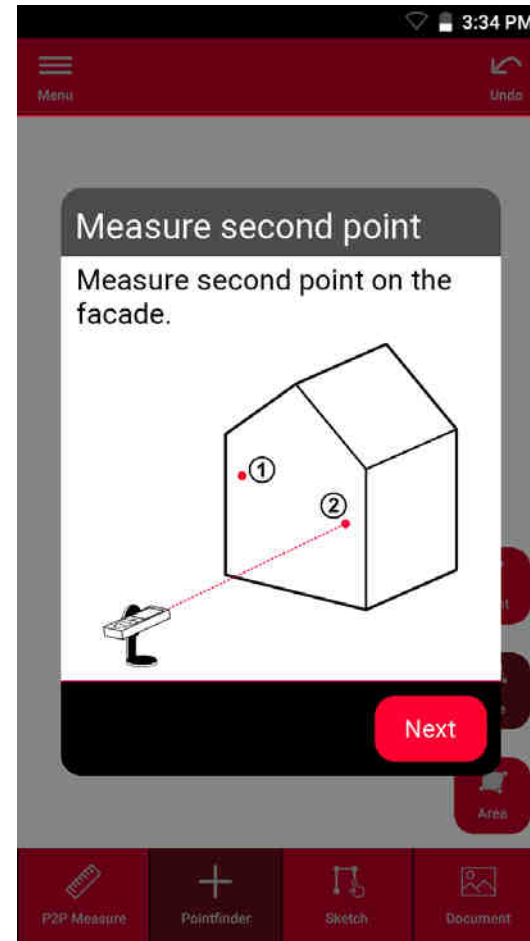
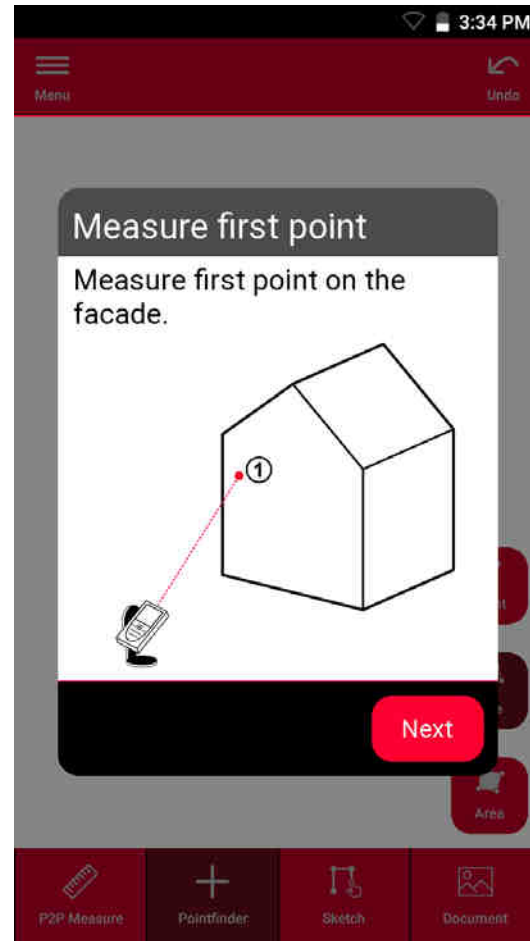
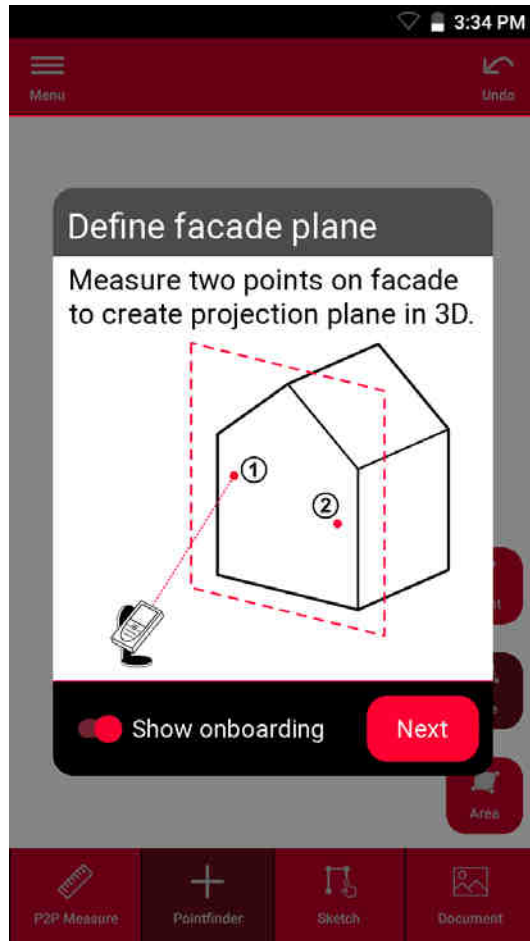

Organiser

Function overview



- ✓ Keeps your work organized in four different categories
- ✓ Helps search and sorting a huge amount of data
- ✓ Delete, rename and move your sketches and plans in project folders
- ✓ Easily export in JPG, PDF and 2D and 3D DWG/DXF format

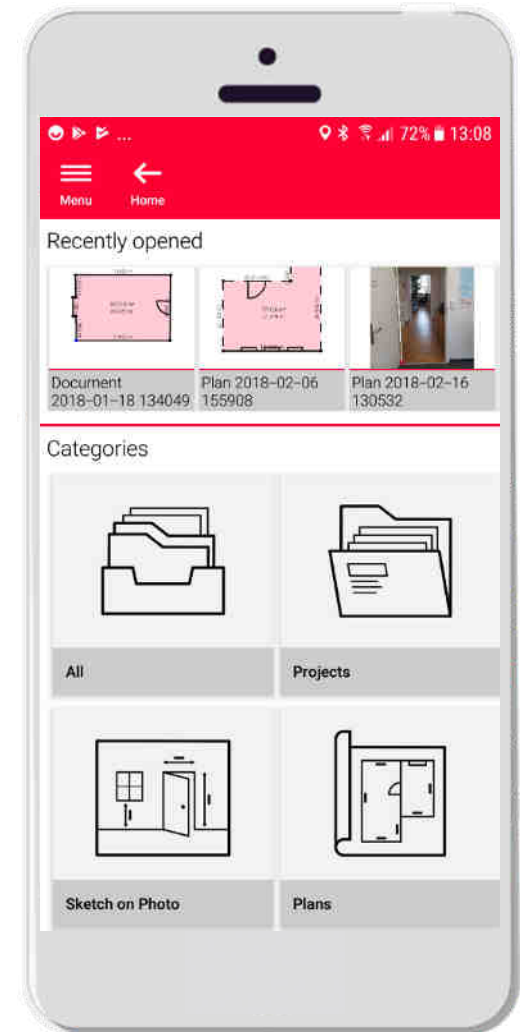

The new Leica DISTO™ Plan App Device Management

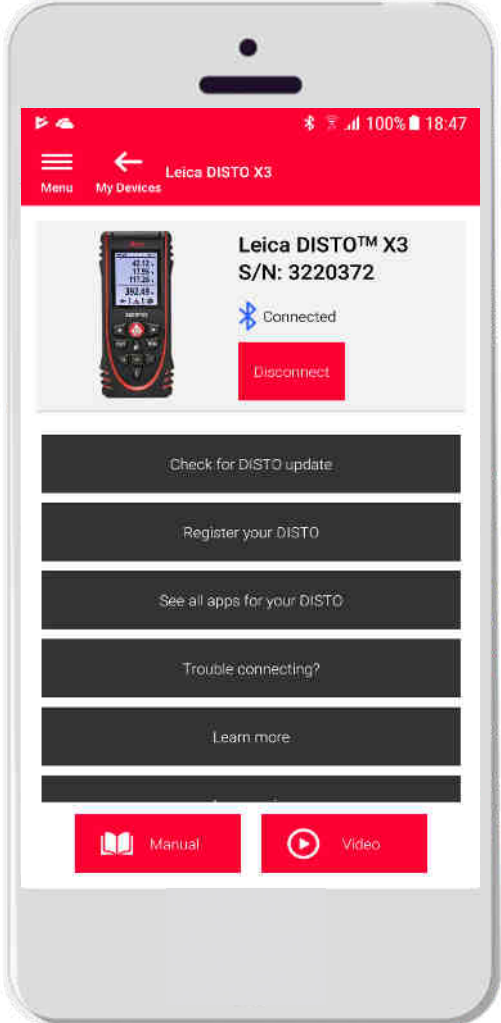

With Leica DISTO Plan you can manage your DISTO Hardware

- ✓ Register for extended warranty
- ✓ Firmware Update
- ✓ Manuals

The new Leica DISTO™ Plan App Pricing



Free functions:

- ❖ Sketch on Photo
- ❖ Sketch Plan
- ❖ Organiser



Available for purchase:

- ❖ Smart Room
- ❖ P2P Measure
- ❖ Basic Export (PDF, JPG)
- ❖ CAD Export (dxf and dwg in 2D/3D/raw)
- ❖ Starter package (includes Smart Room, P2P and Basic Export)

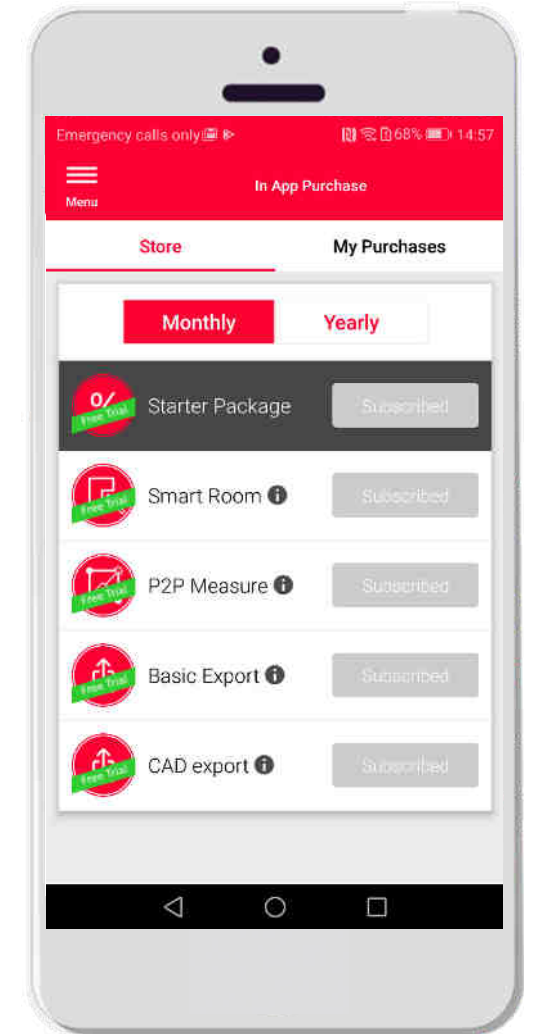

- when it has to be right

Leica
Geosystems

The new Leica DISTO™ Plan App Purchase model

- ✓ Subscription with monthly or yearly billing
 - ❖ Automatic renewal at the end of the subscription period
- ✓ Free 30-day trial for all in-app purchase items
 - ❖ First billing after the trial period!
 - ❖ No costs if the subscription gets cancelled at least one day before the end of the trial period.
- ✓ Cancel subscriptions
 - ❖ At least one day prior to the next billing
 - ❖ Purchases can be managed in the “My Purchases” section

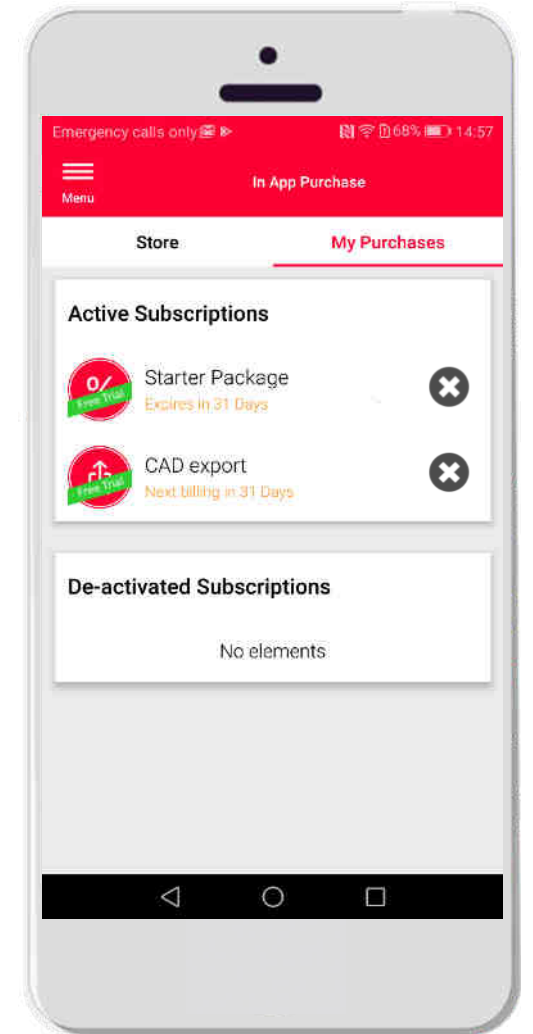

- when it has to be **right**

Leica
Geosystems

Leica DISTO™ X3 and X4

Bluetooth® Smart – document and visualise



Support iOS, Android and Windows®



Create sketches, plans and document your measurements on your smartphone or tablet automatically when taking measurements

What does it mean for the user?



Start the digital workflow with the very first measurement



Avoid documentation and transposing errors, and save time

- when it has to be **right**

Leica
Geosystems

Leica DISTO™ X3/X4 with DISTO™ Plan

Tips and tricks

How to use the keyboard on iOS devices

Note:

DISTO™ X3/X4 are recognized in iOS as keyboards. Therefore the Apple keyboard is not opening.

How to enable the keyboard:

1. Tap into an “Edit value” field
2. Long press (1 sec) the +/- button on your DISTO™

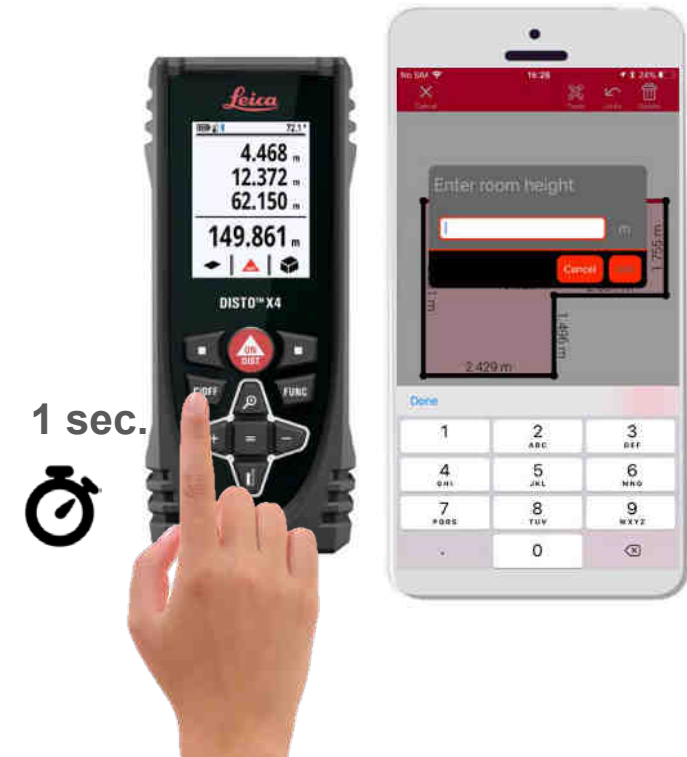

- when it has to be **right**

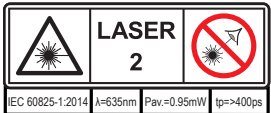

SAP no. 848038

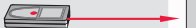

2 sec



min

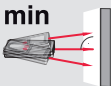

max

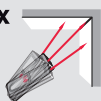

- 1 Status bar/level
- 2 Reference
- 3 Main line (result)
- 4 Active function
- 5 Selection keys linked to the symbol above
- 6 ON/DIST
- 7 Clear/OFF
- 8 Function screen
- 9 Memory
- 10 Add
- 11 Subtract
- 12 Reference
- 13 Navigation



ON



OFF

2 sec

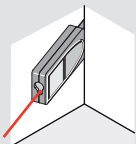
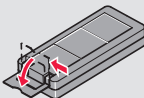
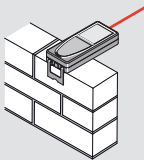
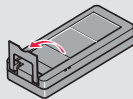

Unlock keypad



Within 2 sec.

Quick Start

Leica DISTO™ X3

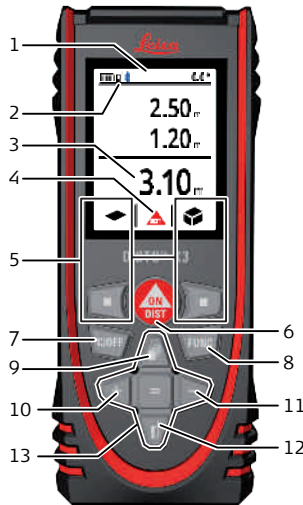

- when it has to be right

FUNC Functions **FUNC**

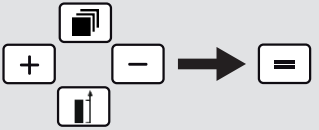

	Single distance measurement
	Area
	Volume
	Room angle
	Smart Horizontal Mode
	Level
	Pythagoras
	Stake out
	Timer
	Point to point measurement*
	Point to point measurement levelled*
	Smart area measurement*

*Activated when connected to DST 360

FUNC Settings

	Tilt units
	Distance units
	Turning screen
	Beep
	Bluetooth®
	Bluetooth® settings
	Illumination
	Favourites
	Keypad lock
	Tilt calibration
	Information / Serial number
	Offset
	Calibration of DST 360*
	Reset

FUNC or ?

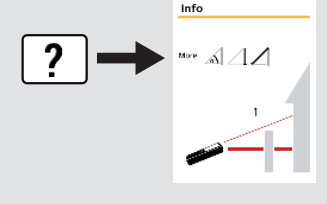

1...20
95.230m³

1/20
5.239m
6.305m
2.883m
95.230m³

Details

Display 1...20

Clear memory

Take over value

Details

